



 1  











7

1

 9

 7

1		1	
		2	"

3		:	
			 ± 5  ± 5
8			  d    b  d   



9			± 5 ± 5
0			± 5 ± 5
1			± 5 ± 5
2			± 5 ± 5
3			± 2 ± 2
4			± 2 ± 2
5			± 5 ± 5



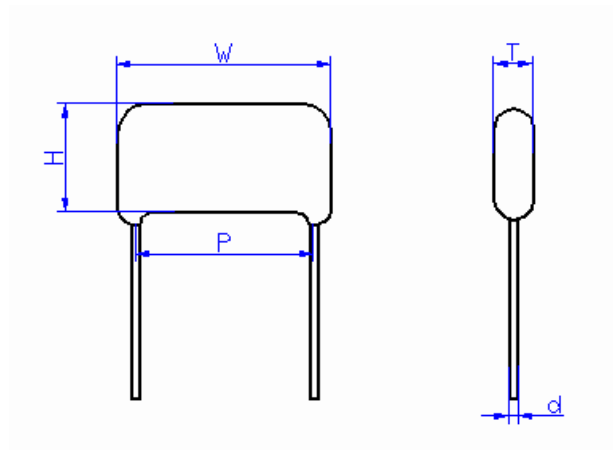

μ																									

